

panel mounting appliance inlet - without hinged cover

Product description

Order number	2600
EAN/pcs	4024941026000
Product Group	GT surface mounting appliance inlet
Amperage	32A
Poles	5p (3p+N+PE)
Earth 'Clock' Position	6 h
Voltage	200/346 up to 240/415V
Frequenz	50 and 60Hz
Protection	IP44
Color code	red RAL 3000
Connection Design	screw terminal
Max. conductor	6,0 mm ²



Further Information

Material

Material of Enclosure	Polyamide
Contact / Contact Carrier	contact carrier made of polyamide, the contacts are brass
Weight/pcs	0.186 kg
Packaging unit	10 ST

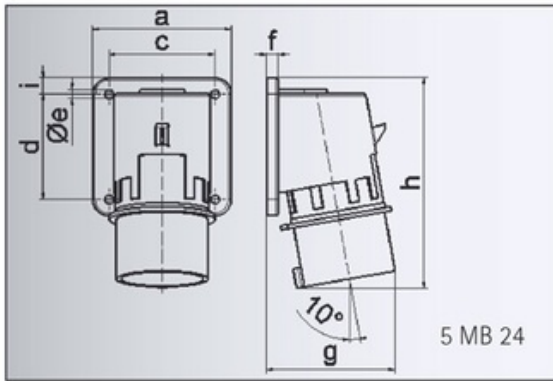

Ampere	16	16	16	32	32	32
Polzahl	3	4	5	3	4	5
a	74,0	75,0	84,0	90,0	90,0	90,0
b	84,0	100,0	84,0	75,0	75,0	75,0
c	58,0	62,0	64,0	78,0	78,0	78,0
d	64,0	74,0	64,0	45,0	45,0	45,0
e ø	5,5	4,3	5,5	5,5	5,5	5,5
f	12,0	12,0	7,0	7,0	7,0	7,0
g	70,0	77,0	78,0	86,0	86,0	88,0
h	128,0	145,0	129,0	138,0	138,0	140,0
i	-	-	-	13,0	13,0	13,0
Leiter mm ² min	1	1	1	2,5	2,5	2,5
Leiter mm ² max	2,5	2,5	2,5	6	6	6