

switched, interlocked - housing dimensions 260x160

Product description	
Order number	16602
EAN/pcs	4024941166027
Product Group	GT wall mounting socket outlet, switched, interlocked
Amperage	63A
Poles	5p (3p+N+PE)
Earth 'Clock' Position	6 h
Voltage	200/346 up to 240/415V
Frequenz	50 and 60Hz
Protection	IP67
Color code	red RAL 3000
Connection Design	screw terminal as box terminal with Kontex-contact
Max. conductor	25.0 mm ²



Further Information	
Cable entry	top entry M40 bottom entry M40/M32
Packaging	260x160 mm (HxW)
Additional technical information	The cable entry is one at top and two at bottom open In 0-position lockable for 4 padlocks with bow diameter up to 7 mm

Material

Material of Enclosure	Polycarbonate
Contact / Contact Carrier	contact carrier made of high temperature resistant material, contacts are brass nickel plated
Weight/pcs	2.300 kg
Packaging unit	1 ST

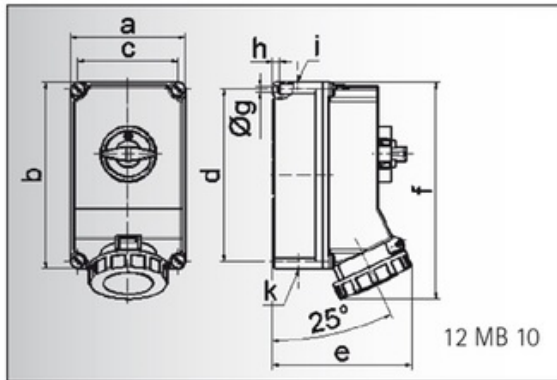

Ampere	63	63	63
Polzahl	3	4	5
a	160,0	160,0	160,0
b	260,0	260,0	260,0
c	140,0	140,0	140,0
d	240,0	240,0	240,0
e	195,0	195,0	195,0
f	304,0	304,0	304,0
g ø	8,1	8,1	8,1
h	10,0	10,0	10,0
i	M40	M 40	M 40
k	M 32/40	M 32/40	M 32/40