

fused - housing dimension 225x118, with mounting rail

Product description	
Order number	15028
EAN/pcs	4024941150286
Product Group	QC wall mounting socket outlet, fused
Amperage	16A
Poles	5p (3p+N+PE)
Earth 'Clock' Position	6 h
Voltage	200/346 up to 240/415V
Frequenz	50 and 60Hz
Protection	IP67
Color code	red RAL 3000
Connection Design	screwless spring terminals as cage clamp with Kontext-contact
Max. conductor	4,0 mm ²



Further Information	
Cable entry	top entry M25/M25 bottom entry M25
Packaging	225x118 mm (HxW)
Additional technical information	The cable entry is one at top open, one at top is closed, and two at bottom are closed With mounting rail Protective cover for fuses with stamping With 5 modules, horizontal

Material	
Material of Enclosure	Polycarbonate
Contact / Contact Carrier	contact carrier made of high temperature resistant material, contacts are brass nickel plated
Weight/pcs	0.875 kg
Packaging unit	1 ST

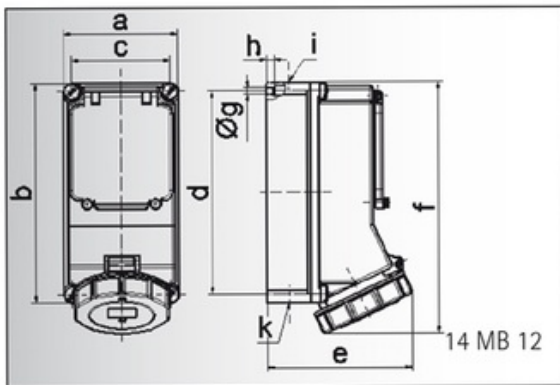

Ampere	16	16	32	32	32
Polzahl	4	5	3	4	5
a	118,0	118,0	118,0	118,0	118,0
b	225,0	225,0	225,0	225,0	225,0
c	101,0	101,0	101,0	101,0	101,0
d	208,0	208,0	208,0	208,0	208,0
e	127,0	134,0	143,0	143,0	149,0
f	245,0	245,0	255,0	255,0	255,0
g ø	6,5	6,5	6,5	6,5	6,5
h	8,0	8,0	8,0	8,0	8,0
i	2 x M 25	2 x M 25	2 x M 25	2 x M 25	2 x M 25
k	2 x M 25	2 x M 25	2 x M 25	2 x M 25	2 x M 25