

Data sheet

Order number: 1157

GT wall mounting socket outlet

EAN/pcs	4024941011570
Ampere	63A
Poles	3p (2P+PE)
Earth 'Clock' Position	6 h
Voltage	200 up to 250V
Frequency	50 and 60Hz
Protection	IP67
Color code	blue RAL 5015
Connection Design	screw terminal as box terminal with Kontex-contact
Contact	contact carrier made of Polyamide, contacts are brass nickel plated
Weight/pcs	0.800 kg
Packaging unit	5 pc/pcs
Material of Enclosure	Polycarbonate



The cable entry is one at top open and two at bottom closed

Lower part of housing rotatable by 180°

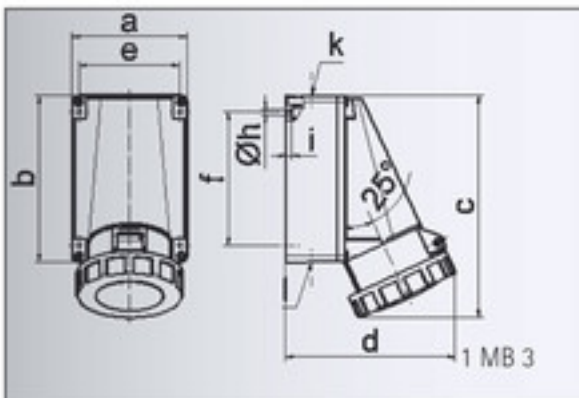

Ampere	63	63	63
Polzahl	3	4	5
a	118,0	118,0	118,0
b	170,0	170,0	170,0
c	228,0	228,0	228,0
d	176,0	176,0	176,0
e	104,0	104,0	104,0
f	136,0	136,0	136,0
h ø	6,1	6,1	6,1
i	6,0	6,0	6,0
k	M 40	M 40	M 40
l	M 32/32	M 32/32	M 32/32
Leiter mm ² min	6	6	6
Leiter mm ² max	25	25	25

Bals Elektrotechnik GmbH & Co. KG

D-57399 Kirchhundem - Albaum

phone: +49(0)2723/771-0 fax: +49(0)2723/771-177

email: info@bals.com www.bals.com

Date: 24.06.2016